

GULLIVER

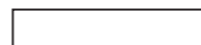

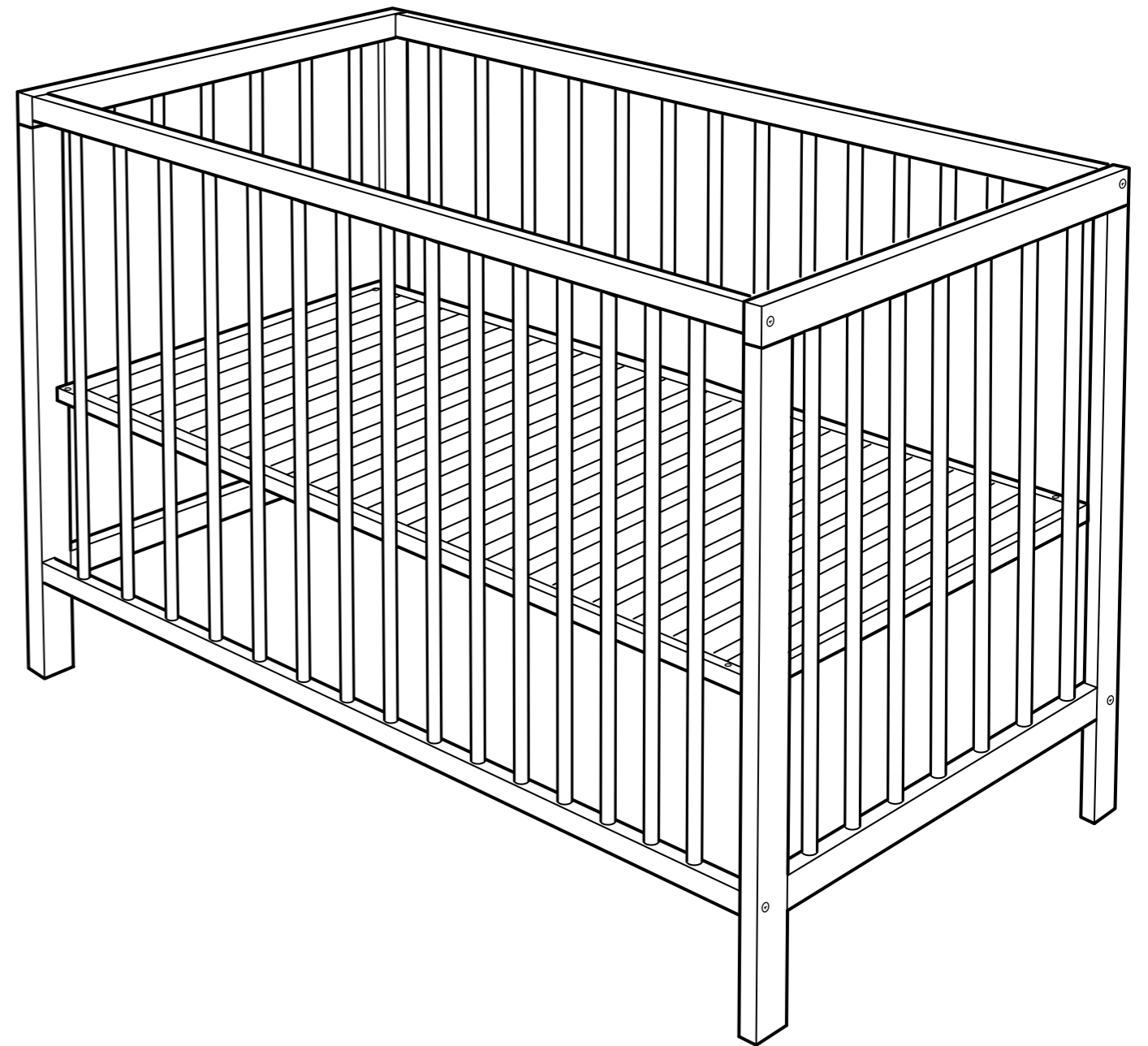

3

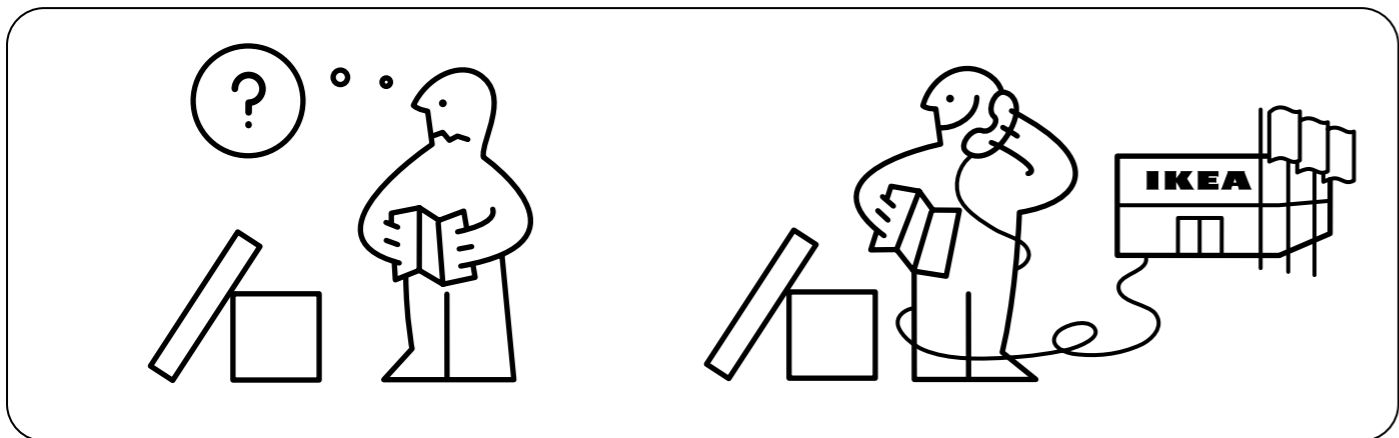
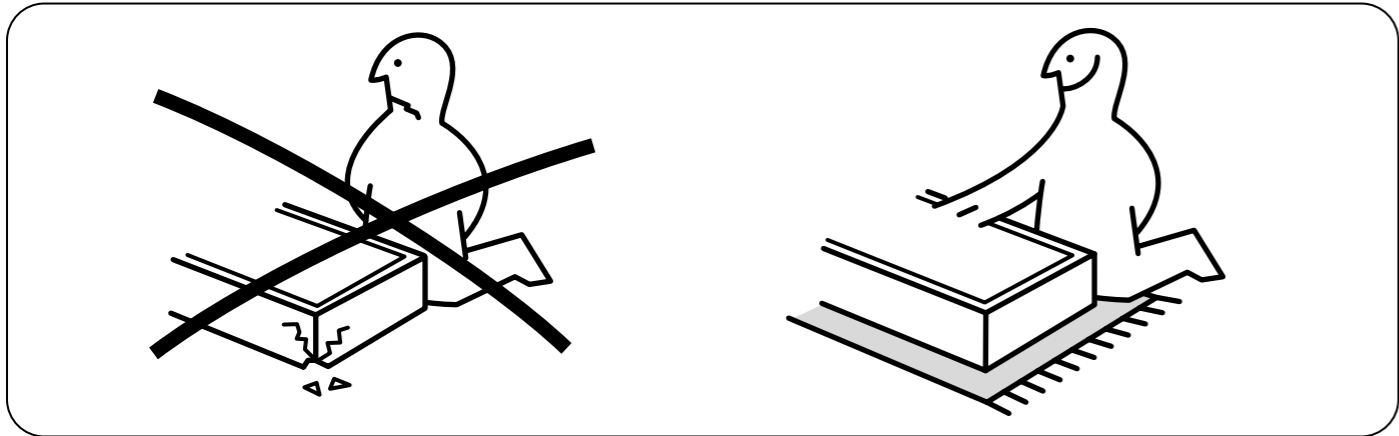
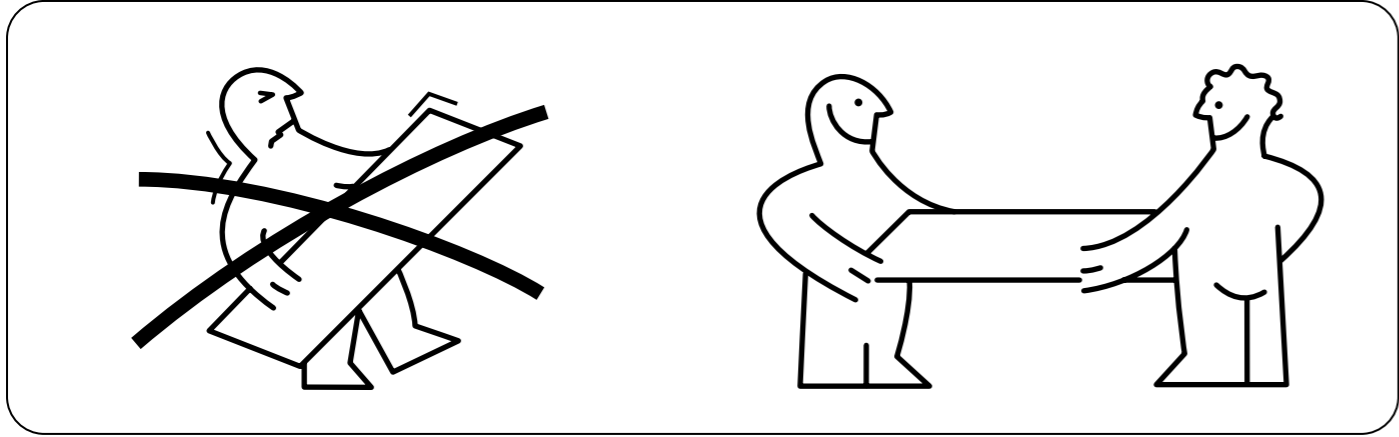
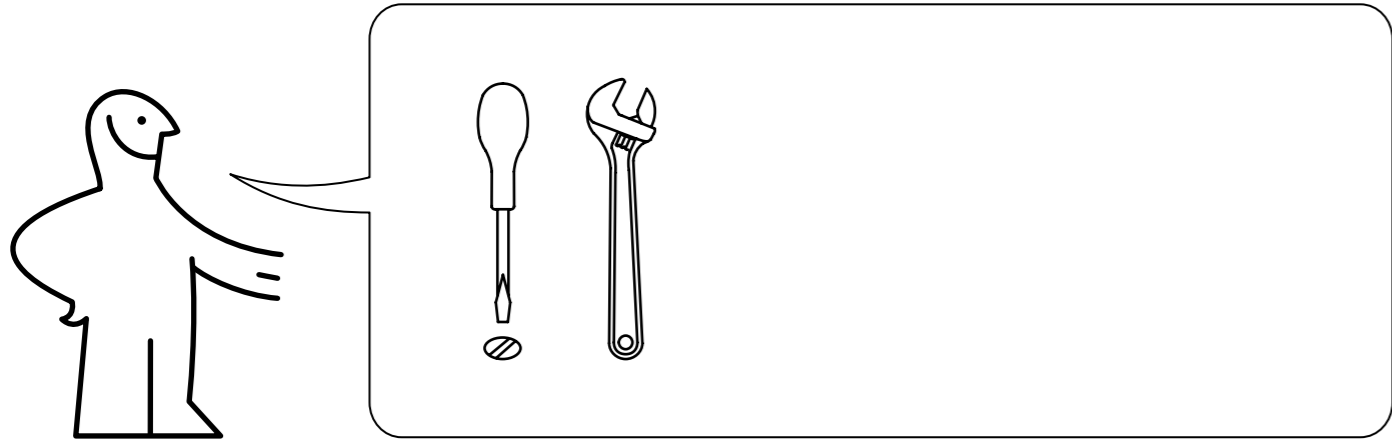
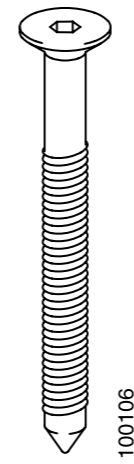
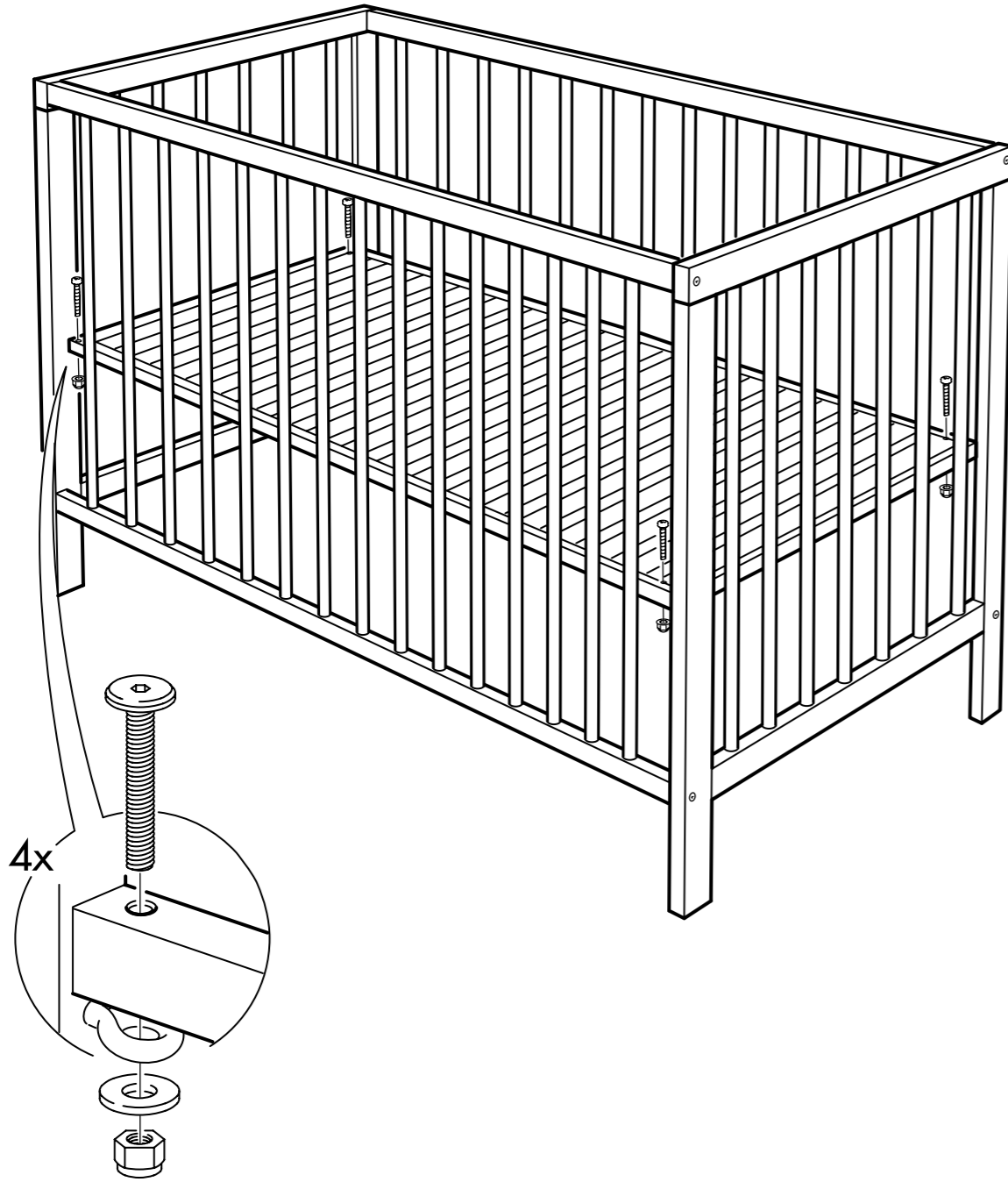
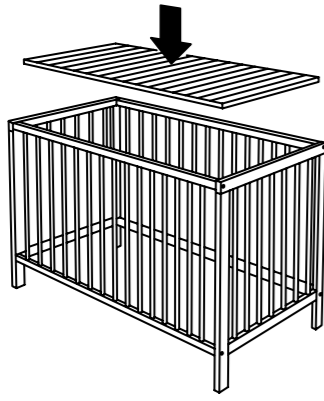

100106

8x

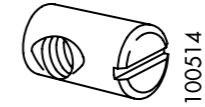

100514

8x

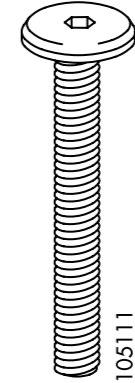

105111

4x



100829

4x



100716

4x

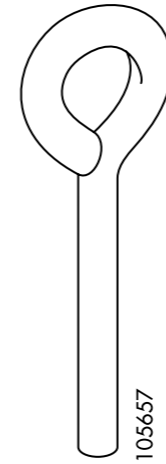

105657

4x

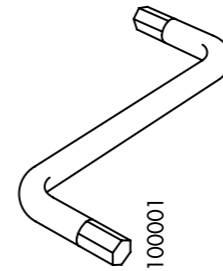

100001

1x

1

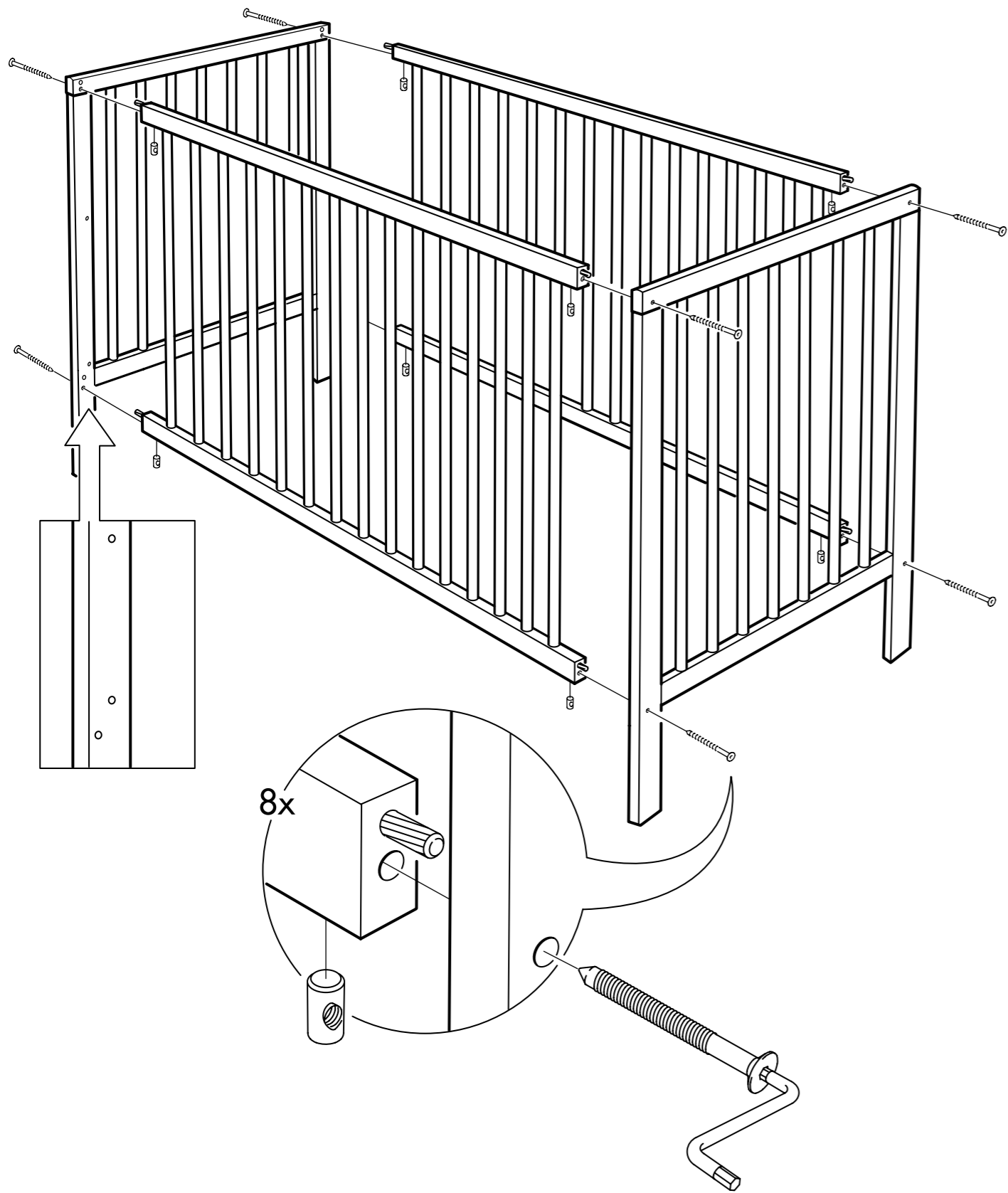

2

